

Classic 1 group, RL technology



Ref: 602636
(CLASSIC1RL)

Traditional Espresso Machine

- 1 Group
- No Steam - Hot Water - Inox Steam
- Inox
- 230 V 1N 50~Hz 3kW
- CE/CB Certified

General Features

The Classic is the perfect traditional espresso machine to guarantee top-quality espresso and consistency even in busy periods.

With elegant lines and reliable technologies appreciated by coffee professionals, the Classic is made even more attractive by its quality/price ratio. The Classic is available in 1, 2 or 3 group configurations.

Classic 1 group, RL technology

Main Features

- The CLASSIC Elegant lines and reliable technologies appreciated by coffee professionals, the CLASSIC model is made more attractive by its quality/ price ratio. The CLASSIC is the perfect traditional espresso machine to ensure an excellent quality espresso result, and consistency even during the busiest periods of the day.
- Heavy duty components and welded construction, a direct mounted boiler group head for thermal stability and reliable extraction, easy access to components for uncomplicated servicability, and unlimited steam.
- Maestro brew group: directly to boiler group heads are mounted for shot temperature stability.
- Large cup warming capacity: integrated cup warmer on the top of the machines.
- 4 programmable volume keys per group + Semi-automatic key for each group for manual control.
- Automatic cleaning program.

Construction

- Built-in cup warmer.

Included Accessories

- 1 of Filter holder for one cup PNC 871002
- 1 of Filter holder for two cups PNC 871003

Optional Accessories

- Filter holder for one cup PNC 871002
- Filter holder for two cups PNC 871003
- Filter holder for three cups PNC 871004
- Filter for one cup, 12 gr PNC 871017
- Filter for two cups, 18 gr PNC 871018
- Stainless steel knock box drawer PNC 871019

Classic 1 group, RL technology

Electric

Supply voltage:

602636 (CLASSIC1RL) 230 V/1N ph/50 Hz

Electrical power max.: 3 kW

Plug type: Cable without plug

Water:

Cold water temperature

(min/max): 5 / 60 °C

Key Information:

External dimensions,

Width: 343 mm

External dimensions,

Depth: 568 mm

External dimensions,

Height: 580 mm

Net weight: 41 kg

Shipping volume: 0.32 m³

Sustainability

Current consumption: 13 Amps

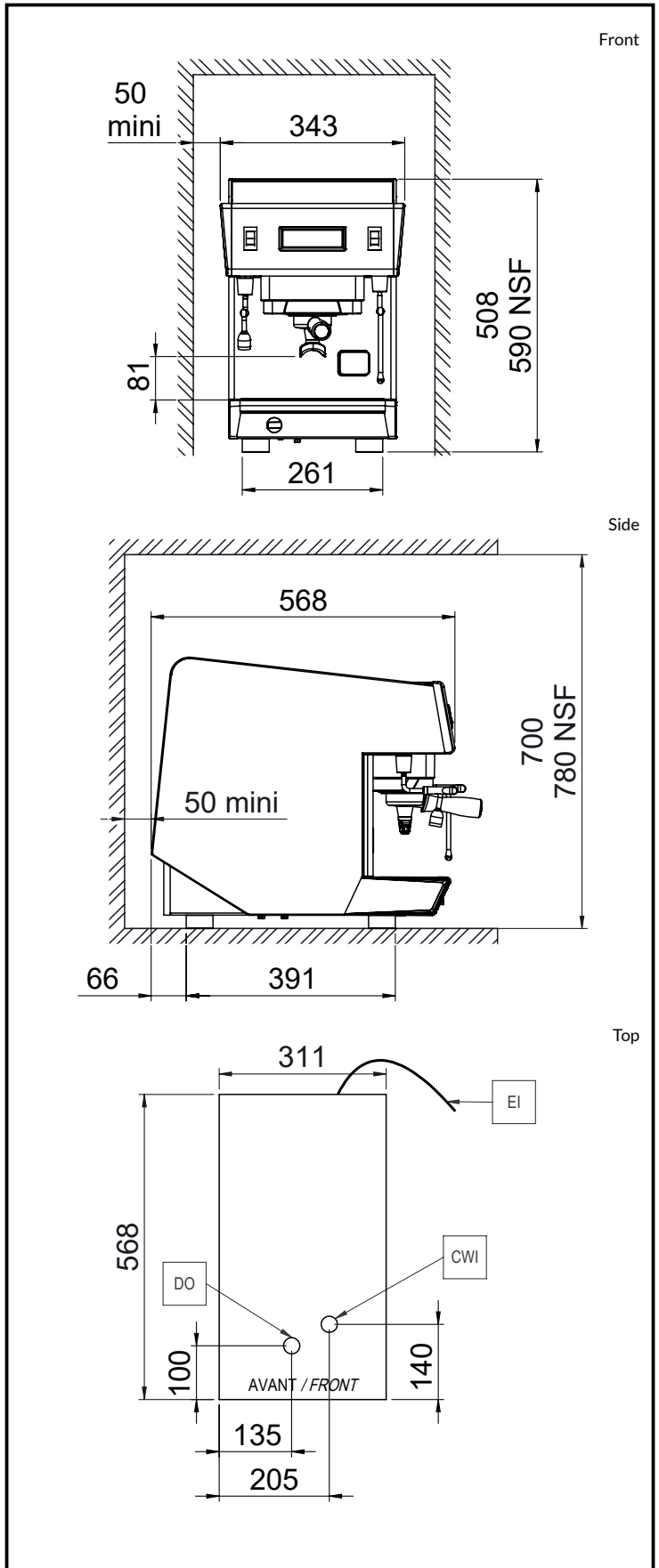

Certifications



The company reserves the right to make modifications to the products without prior notice. All information correct at time of printing.

2025.01.18

Part of  Electrolux Professional Group

UNIC